

Industrie-Mobilkran

7 t

Tragfähigkeit Rollen Strangzahl Gewicht Höhe

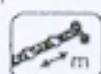

5,1 - 21,2 m



7 t	3	6	76 kg	600 mm
1,4 t	-	1	25 kg	500 mm



11.635 kg



14 KN

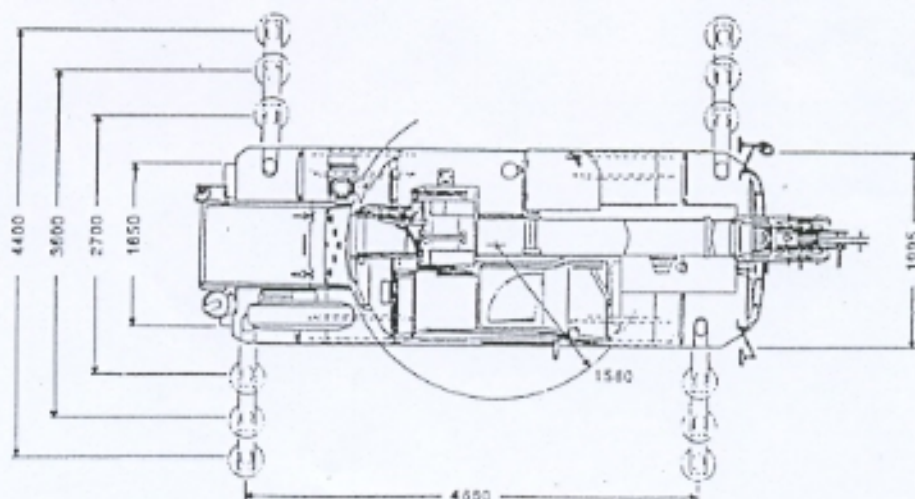
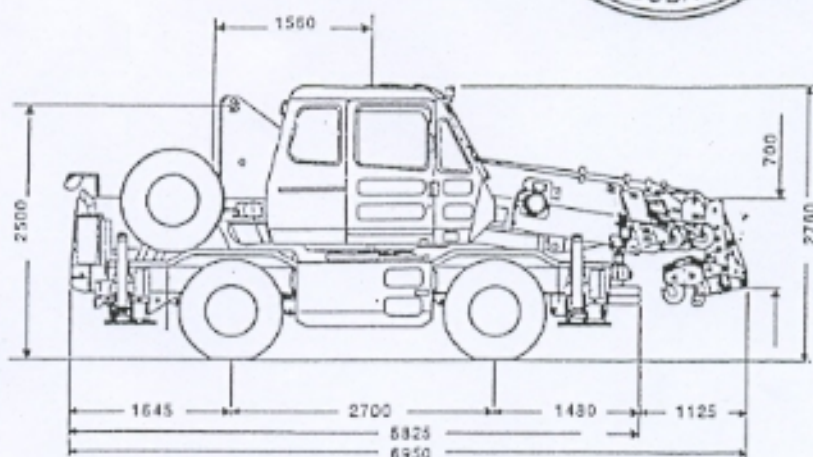

KOBELCO

7 t

Industrie-Mobilkran

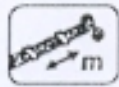

Arbeitsbereiche

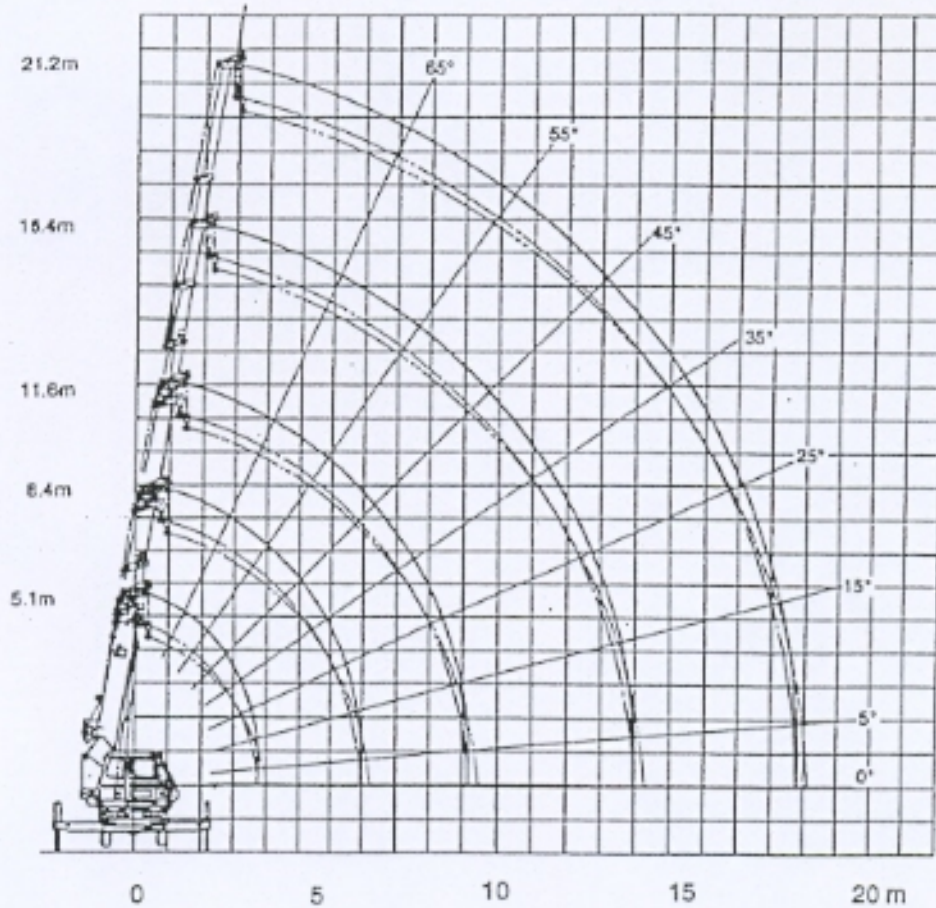

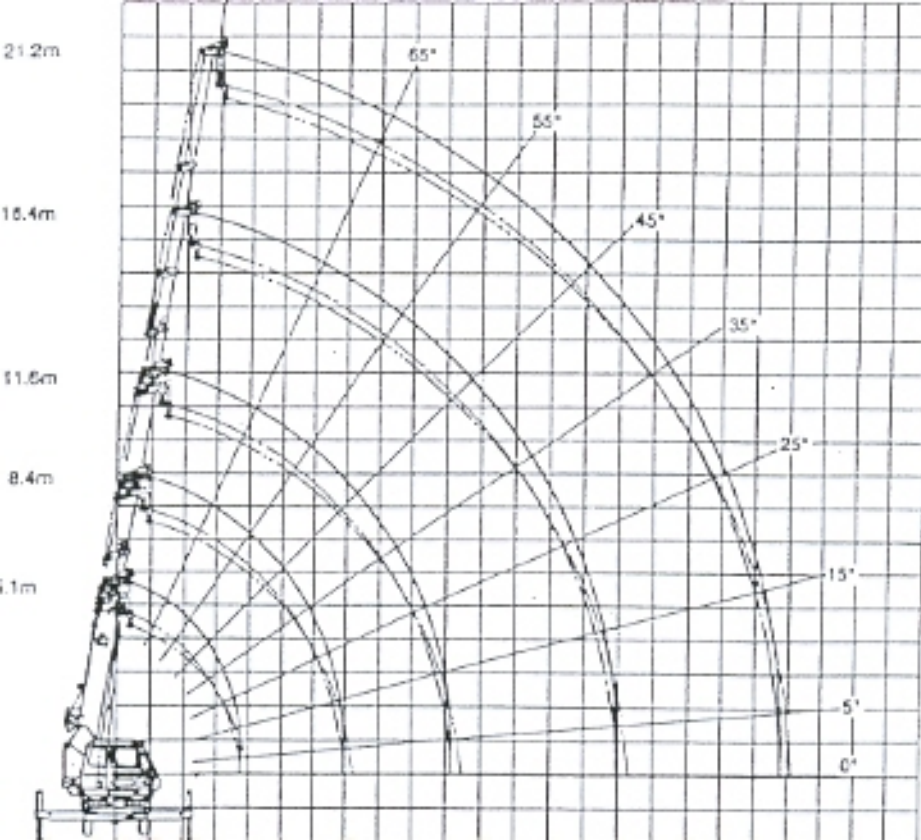

7 t

Industrie-Mobilkran



5,1-21,2 m

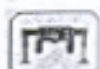



4,66 x 2,7 m



360°

75%

 m	5,1 m	8,4 m	11,6 m	16,4 m	21,2 m	 m
1	7	4,9				1
1,5	7	4,9	4,9			1,5
2	7	4,9	4,9			2
2,5	7	4,9	4,9	3,9		2,5
3	6,1	4,9	4,1	3,9	2	3
3,5	4,4	4,07	3,6	3,9	2	3,5
4	4	3,26	2,98	3,6	2	4
4,5		2,63	2,4	2,9	2	4,5
5		2,1	1,98	2,43	2	5
5,5		1,71	1,64	2,05	1,85	5,5
6		1,4	1,36	1,76	1,7	6
7		0,9	1	1,31	1,3	7
8			0,66	0,96	0,97	8
9			0,41	0,7	0,76	9
10			0,23	0,5	0,6	10
11				0,34	0,47	11
12				0,21	0,35	12
13					0,26	13
14					0,17	14



7 t

Industrie-Mobilkran



5,1 - 21,2 m



4,66 x 3,6 m



360°

75%

	5,1 m	8,4 m	11,6 m	16,4 m	21,2 m	
1	7	4,9				1
1,5	7	4,9	4,9			1,5
2	7	4,9	4,9			2
2,5	7	4,9	4,9	3,9		2,5
3	6,1	4,9	4,9	3,9	2	3
3,5	5,3	4,9	4,9	3,9	2	3,5
4	4,5	4,5	4,5	3,6	2	4
4,5		3,85	3,87	3,3	2	4,5
5		3,33	3,37	3,05	2	5
5,5		2,85	2,97	2,82	1,85	5,5
6		2,46	2,52	2,56	1,7	6
7		1,8	1,87	2,03	1,5	7
8			1,4	1,57	1,33	8
9			1,02	1,22	1,18	9
10			0,78	0,96	1,04	10
11			0,7	0,75	0,91	11
12				0,57	0,78	12
13				0,44	0,65	13
14				0,34	0,53	14
15				0,27	0,42	15
16					0,33	16
17					0,26	17
18					0,19	18
19					0,13	19



7 t

Industrie-Mobilkran



5,1 - 21,2 m





4,66 x 4,4 m



360°

75%

	5,1 m	8,4 m	11,6 m	16,4 m	21,2 m	
1	7	4,9				1
1,5	7	4,9	4,9			1,5
2	7	4,9	4,9			2
2,5	7	4,9	4,9	3,9		2,5
3	6,1	4,9	4,9	3,9	2	3
3,5	5,3	4,9	4,9	3,9	2	3,5
4	4,5	4,5	4,5	3,6	2	4
4,5		3,85	3,87	3,3	2	4,5
5		3,33	3,37	3,05	2	5
5,5		2,95	2,97	2,82	1,85	5,5
6		2,62	2,65	2,56	1,7	6
7		2,1	2,14	2,15	1,5	7
8			1,7	1,84	1,4	8
9			1,4	1,6	1,23	9
10			1,2	1,4	1,09	10
11			1	1,2	0,98	11
12				1,02	0,89	12
13				0,85	0,82	13
14				0,69	0,75	14
15				0,55	0,69	15
16					0,59	16
17					0,51	17
18					0,43	18
19					0,36	19
20					0,3	20

